

Service Manual

VRV4 indoor units

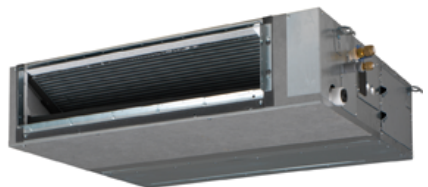
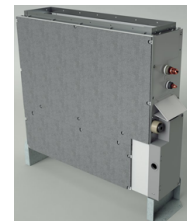
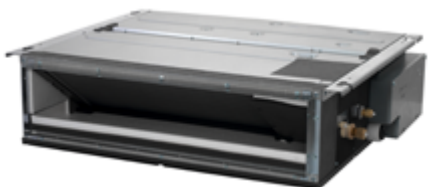

BRYQ-A

FVKQ-M

FXDQ-M

FXHQ-A

FXLQ

BYCQ-D

FXFQ-P

FXUQ-A

FXDQ-A

FXNQ

CAV/CYV

FXCQ-A

FXFQ-A

FXZQ-A

FXSQ-A

VKM

FXSQ-P

FXMQ-P

FXAQ-P/A

FXTQ-A

The present publication is drawn up by way of information only and does not constitute an offer binding upon Daikin Europe N.V. Daikin Europe N.V. has compiled the content of this publication to the best of its knowledge. No express or implied warranty is given for the completeness, accuracy, reliability or fitness for particular purpose of its content and the products and services presented therein. Specifications are subject to change without prior notice. Daikin Europe N.V. explicitly rejects any liability for any direct or indirect damage, in the broadest sense, arising from or related to the use and/or interpretation of this publication. All content is copyrighted by Daikin Europe N.V.

Table of contents

Part 1. Introduction	5
1. Version log	5
2. System description	6
2.1. General system layout of a VRV heat recovery system	6
3. General operation of VRV heat recovery system	9
4. How to use this book	10
4.1. Interactive information flow	10
 Part 2. Troubleshooting	 11
1. How to retrieve error code and data?	11
1.1. Wired remote controller BRC1D	11
1.1.1. Access to error code	11
1.1.2. Access to inspection menu	11
1.1.3. Access to Service menu	13
1.2. Wired remote controller BRC1/2/3E	14
1.2.1. Access to error code	14
1.2.2. Access to service menu	15
1.3. Wireless controller BRC4/7	17
1.3.1. Access to error code	17
2. Error code based troubleshooting	18
 Part 3. Field settings	 21
1. Wireless remote controller BRC4C and BRC7C/E	21
1.1. Access field settings	21
2. Wired remote controller BRC2/3E52	22
2.1. Access field settings	22
2.2. Field settings, specific for wired remote controller BRC2/3E52	25
3. Wired remote controller BRC1D51/52	27
3.1. Access field settings	27
3.2. Field settings, specific for BRC1D51/52	28
4. Wired remote controller BRC1E51	30
4.1. Access field settings	30
4.2. Field settings, specific for BRC1E51	32
5. Wired remote controller BRC1E52	35
5.1. Access field settings	35
5.2. Field settings, specific for BRC1E52	37
6. General indoor units	41
7. Presence sensor BRYQ140A7 (for 3x3 cassette) / BRYQ60A7 (for 2x2 cassette)	46
8. Selfcleaning panel BYCQ140D7G	47
9. Aircurtain CAV/CYV	48
10. VKM	48
11. FXSQ-A / FXNQ-A / FXDQ-A / FXMQ-P/MB / FXTQ-A	51
12. Factory settings	53
12.1. How to perform factory reset of settings through remocon	53
12.2. Field settings as per type indoor unit	55

Part 1. Introduction

1. Version log

Version code	Description	Date
ESIE15-11	Release	10/12/15
ESIE15-11A	Add error codes A0, A1, A7, A9-01, A9-02, UE	23/09/16
ESIE15-11B	Addition of model FXAQ-A (no changes compared to FXAQ-P except casing)	04/09/17

2. System description

This system description explains the concept of the VRV4 H/R. All settings in this book however, are applicable to indoor units that can be connected to VRV4 HP, mini-VRV4, VRV i-series, VRV4 high ambient and VRV4 water-cooled.

2.1. General system layout of a VRV heat recovery system

The VRV heat recovery system consists of 3 different types of units:

- outdoor unit(s)
- BS unit (Branch Selector unit)
- indoor units.

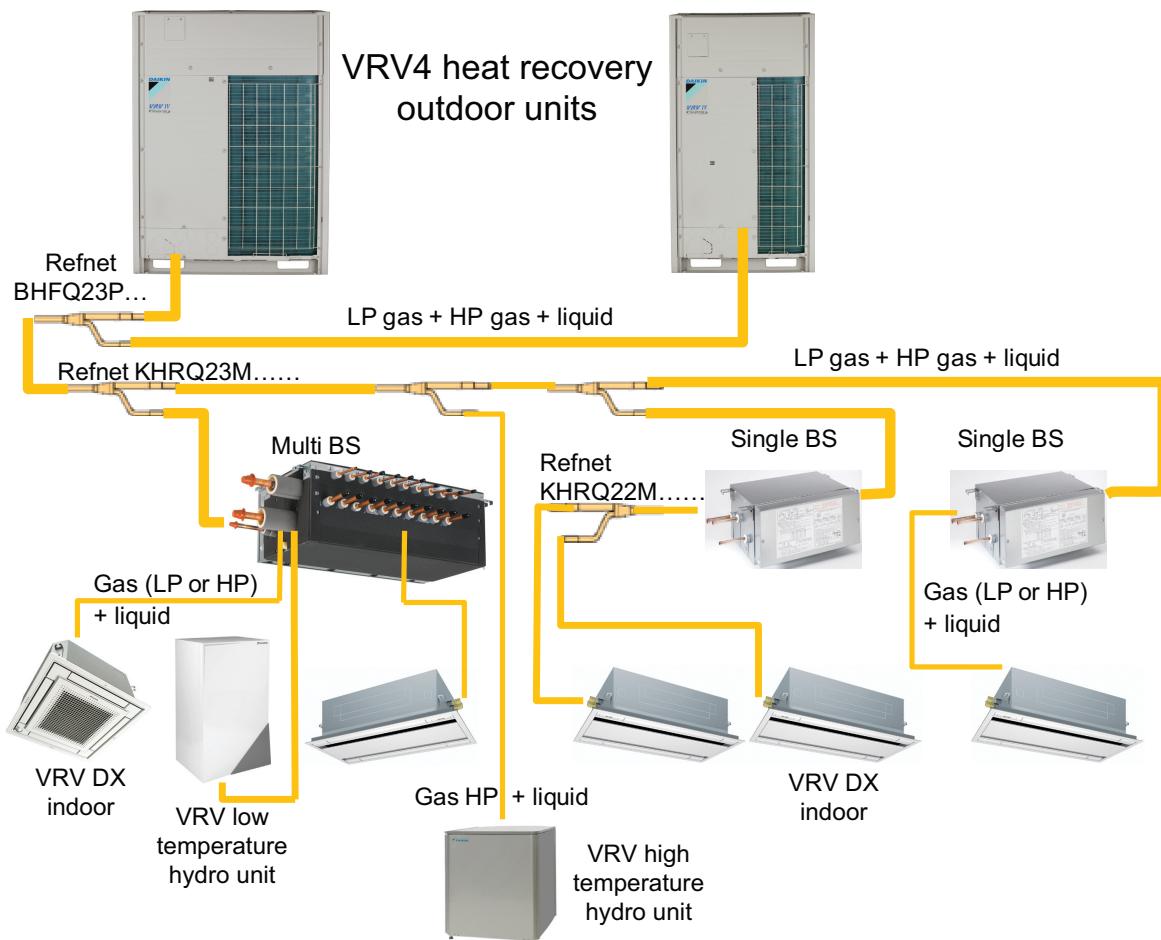

- One to maximum three modules of VRV4 heat recovery outdoor unit can be connected using the optional refnet “BHFQ23P...”.
- Field piping must be thermally insulated copper piping, connected to a combination of “Single circuit BS” unit(s), or/and “Multi circuit BS” unit(s).
- The “Single circuit BS” unit offers 1 change-over circuit. A “Multi circuit BS” unit offers 4, 6, 8, 10, 12 or 16 outlets.
- To split the refrigerant circuit between outdoor unit(s) and the different BS units, Daikin optional accessory refnets (reference “KHRQ23M...”) are used.
- Behind the BS unit, one or more indoor units can be connected. To split the refrigerant circuit to the different indoor units to the same BS unit, Daikin optional accessory refnets (reference “KHRQ22M...”) are used.
- The HT (high temperature) hydrobox is connected without BS unit: only use the HP (high pressure) gas line and the liquid line.

- Outdoor units exist in different capacities. Two types of casings are used:
 - “Medium” casing: REMQ5T7Y1B, REYQ8~12T7Y1B
 - “Large” casing: REYQ14~20T7Y1B
 - The unit REYQ8~20T7Y1B can be used as “single” unit or combined into a “multi” outdoor combination of maximum three units (refer to databook).
 - The unit REMQ5T7Y1B can only be used in multi 2* REMQ5T7Y1B or REMQ5T7Y1B + REYQ8T7Y1B.

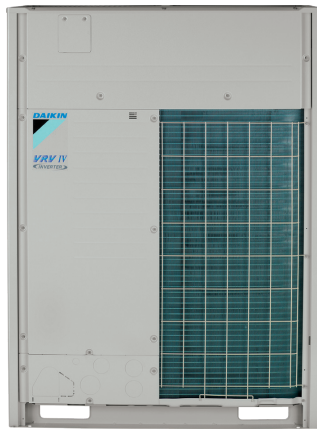

“Large” casing



“Medium” casing

2. BS "branch selector" units exists in:

- "Single circuit" BS units: 3 capacities available depending on total capacity indoor units:
 - BS1Q10A: indoor index below 100 (100 not included).
 - BS1Q16A: indoor index from 100 and below 160.
 - BS1Q25A: indoor index from 160 till 250 (250 included).

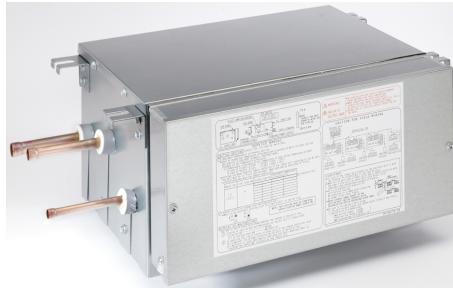

BS1Q10, 16, 25A

- "Multi circuit" BS units:
 - The maximum number of circuits depend on the model:
 - BS4Q14A: maximum 4 circuits.
 - BS6Q14A: maximum 6 circuits.
 - BS8Q14A: maximum 8 circuits.
 - BS10Q14A: maximum 10 circuits.
 - BS12Q14A: maximum 12 circuits.
 - BS16Q14A: maximum 16 circuits.

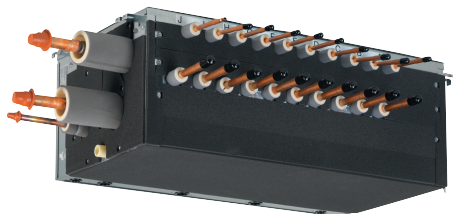

BS10Q14A

- Each circuit can have:
 - Maximum five indoor units.
 - Maximum index 140.

3. Indoor units:

- The current available type VRV DX units can be used. Minimum 50% of outdoor index must be connected through BS unit(s).
- The LT (low temperature) hydro unit can be added (BS unit required).
- The HT hydro unit can be added (without BS unit).

3. General operation of VRV heat recovery system

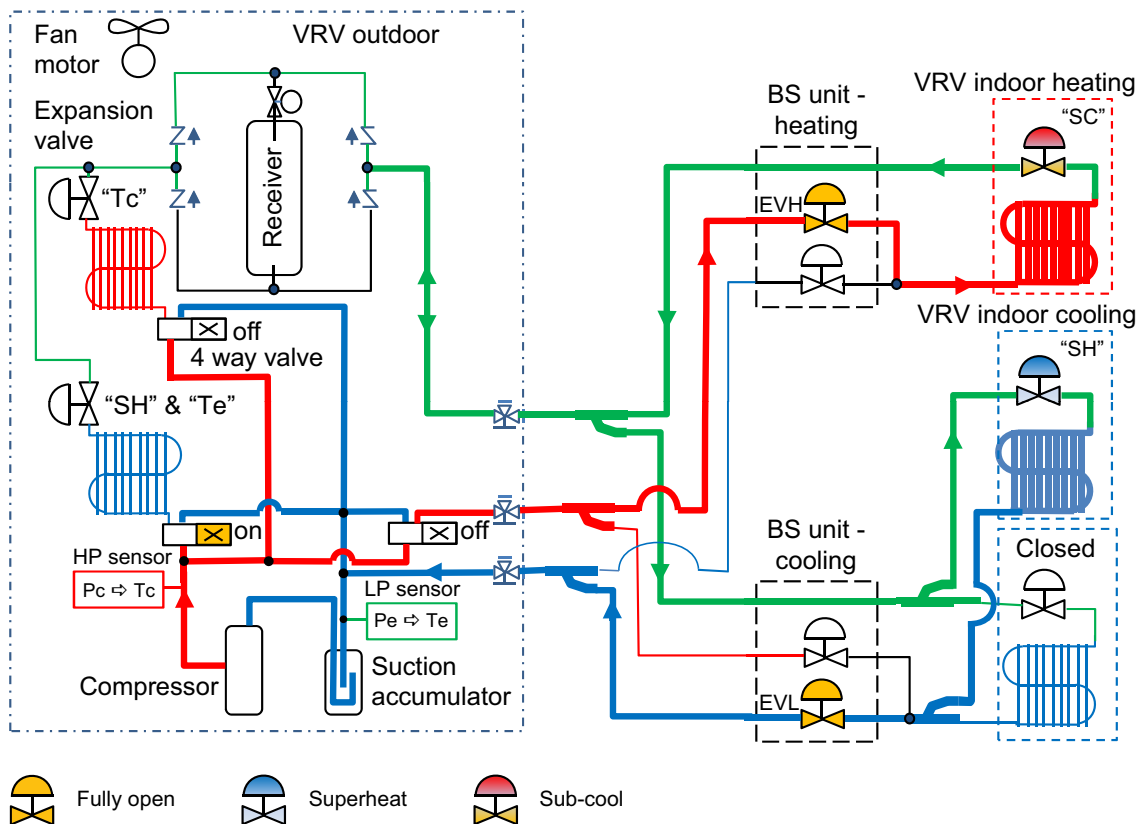

- When indoor unit is selecting heating mode, discharge gas is supplied by the outdoor unit(s) into the dual pressure line through EVH (high pressure expansion valve) fully opened in the BS unit to the indoor unit.
- When indoor unit is selecting cooling mode, suction gas returns from indoor unit gas line through EVL (low pressure expansion valve) fully opened in the BS unit to the outdoor unit.
- Indoor unit in cooling controls the indoor expansion valve on suction superheat (SH) by comparing gas and coil sensor on indoor unit.
- Indoor unit in heating controls the indoor expansion valve on liquid sub-cool (SC) by comparing Tc (outdoor condensing temperature) derived from reading of high pressure sensor, and indoor coil temperature.
- When indoor unit requires change over between cooling and heating, the switching between suction and discharge line is performed only in the BS unit that received the request of indoor unit to change over. Change over sequence is explained in "General built up VRV4 BS unit".
- Outdoor can switch outdoor heat exchanger separately condenser/evaporator in function of unbalance between cooling and heating demand indoor side.

4. How to use this book

4.1. Interactive information flow

This Daikin product Service Manual is intended for professional use only. The actions described hereafter, are only to be performed by qualified and certified persons.

By following the diagram below, the reader can find the relevant information related to his/her task. The digital (pdf) version of this book allows direct page access through all active links. When Adobe Acrobat Reader is used, the <Alt> + <Back Arrow> keys can be used to return to the previously viewed page.

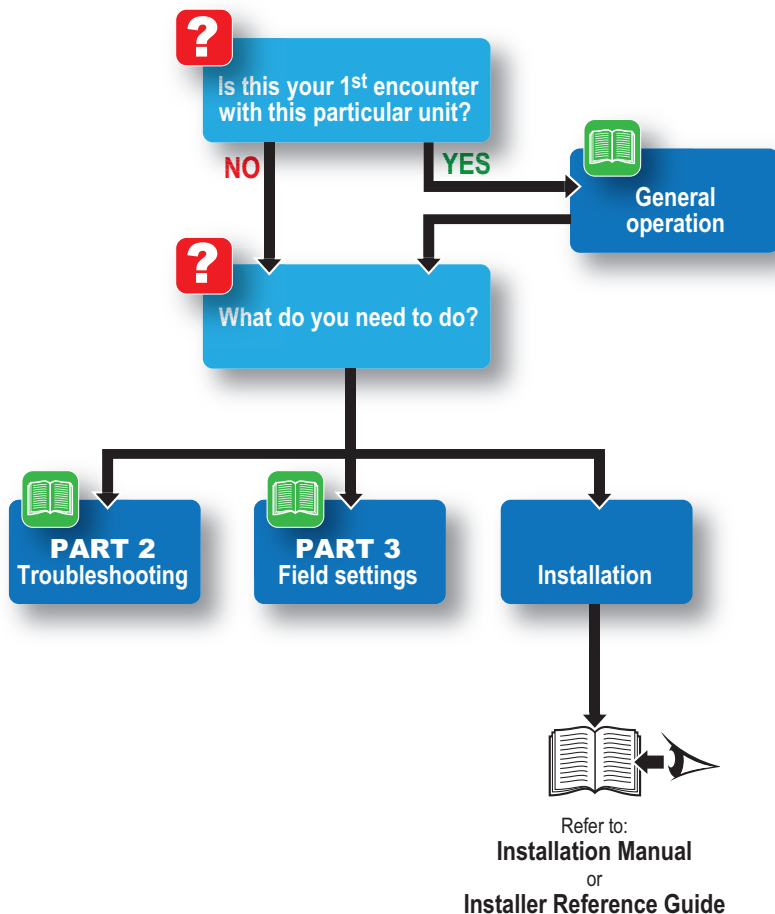

Part 2. Troubleshooting

This part contains the following chapters:

1. How to retrieve error code and data?	11
2. Error code based troubleshooting.....	18

1. How to retrieve error code and data?

1.1. Wired remote controller BRC1D

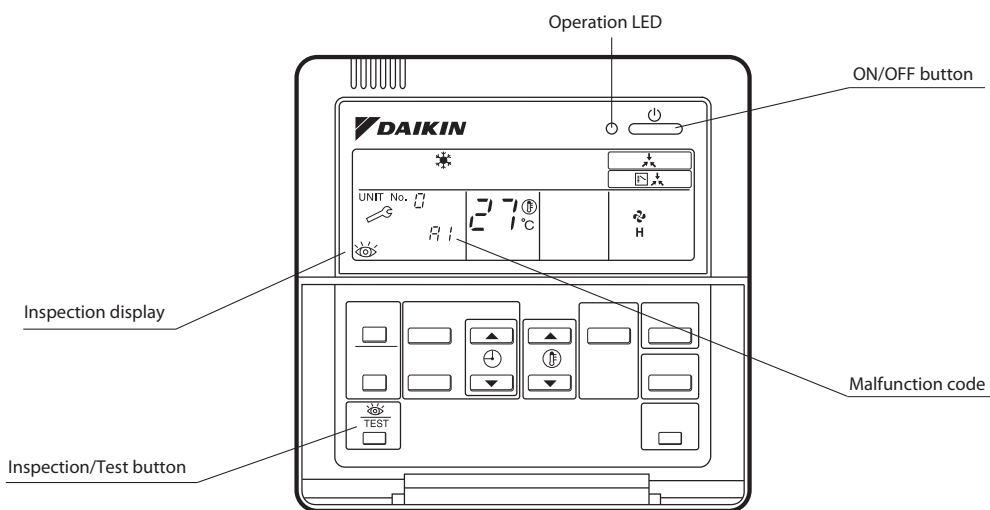

1.1.1. Access to error code

If operation stops due to malfunction, the remote controller's operation LED blinks, and malfunction code is displayed. (Even if stop operation is carried out, malfunction contents are displayed when the inspection mode is entered.)

The malfunction code enables you to tell what kind of malfunction caused operation to stop.

1.1.2. Access to inspection menu

In the inspection menu, you can check the error codes, indoor unit model code, outdoor unit model code and start test operation if required.

To enter Inspection menu, push the TEST button once. The symbol of an eye (inspection) will light up on the remote controller display.

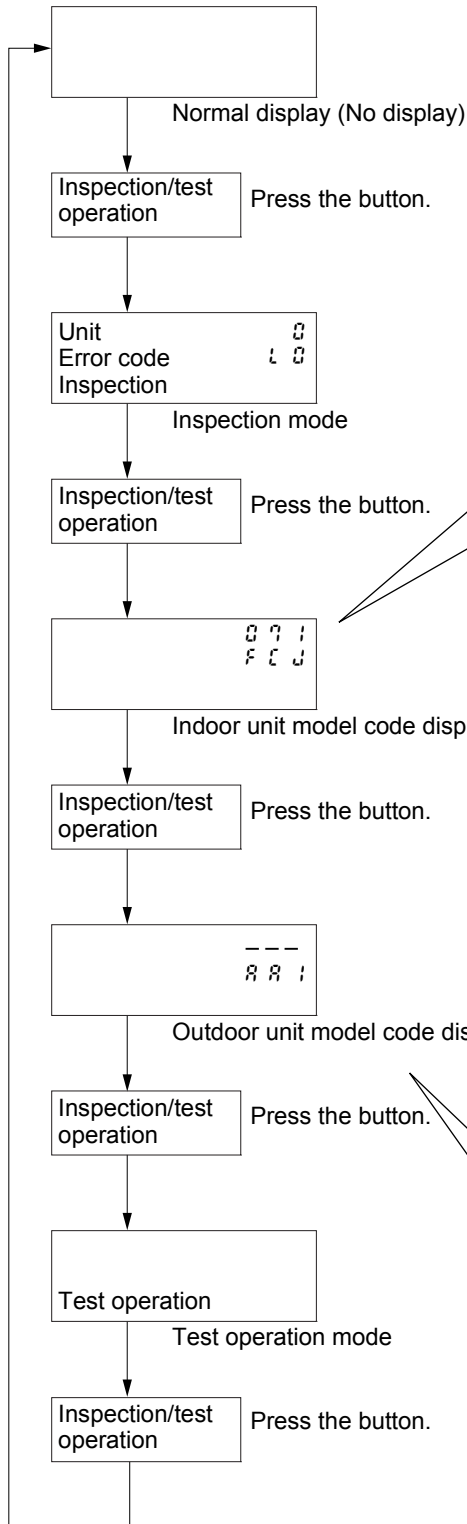

Unit 0
 Error code L 0
 Inspection

Error code blinks when an error occurs.

0 7 1 ... Capacity code
 F ... Indoor unit system code
 C ... Indoor unit type code
 U ... Progression code

Example of capacity code display

Example model	Display
FXCQ25	028
FXFQ63	071

Indoor unit system code

Display	Product classification	System classification
1	VRV system	(VAV indoor unit)
2	VRV system	Outdoor air processing unit
F	VRV system	Standard indoor unit
H	VRV system	New ceiling suspended cassette

Indoor unit type code

Display	Type	Model
R	Wall mounted	FXAQ
C	2-way blow	FXCQ
E	Corner	FXKQ
F	Round flow	FXFQ
H	Ceiling suspended	FXHQ
J	Concealed ceiling	FXSQ
P	Floor standing	FXLQ
U	Concealed ceiling	FXMQ
L	Concealed floor standing type	FXNQ
S	600×600 4-way blow	FXZQ
3	Slim concealed ceiling	FXDQ

Outdoor model code

Display	Type	Model
R R 1	VRV System Inverter K Series	RSXYP
R R 3	R-407C VRV PLUS Series	RXYP
R S 2	VRV Heat Recovery Series	RSEYP
R R 5	High COP type R-407C L Series	RSXYP-L
R R R	VRV II	RXYQ-M
R R C	VRV II M/C	RXYQ-MA
R R E	VRV III Heat Pump Series	RXYQ-P
		Cooling Only Series
R S E	VRV III Heat Recovery Series	REYQ-P
R S E	VRV III-C Heat Pump Series	RTSYQ-PA



1.1.3. Access to Service menu

When there is no error displayed but unit is behaving strangely, you can also check some more operational data in the Service mode.

How to access the Service menu:

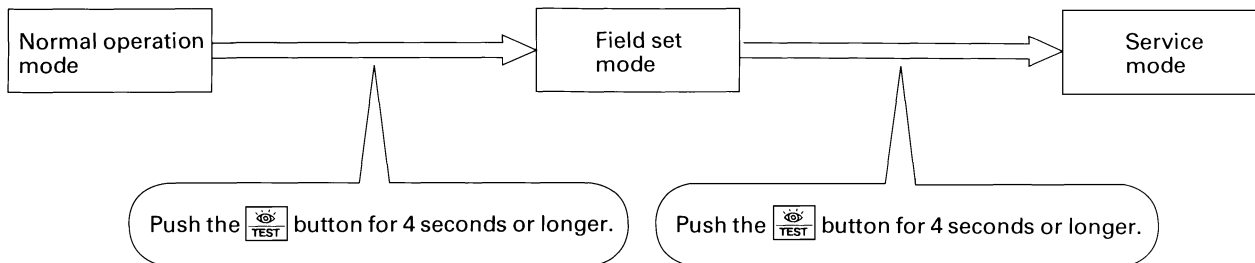

(VF020)

In the Service menu you can find below information:

Mode No	Function	Contents and operation method	Remote controller display example
40	Malfunction history display	<p>Display malfunction history.</p> <p>The history No. can be changed with the button.</p>	<p>Unit 1 Malfunction code 40</p> <p>2-U4 Malfunction code</p> <p>History No: 1 - 9 1: Latest</p> <p>(VE007)</p>
41	Display of sensor and address data	<p>Display various types of data.</p> <p>Select the data to be displayed with the button.</p> <p>Sensor data 0: Thermostat sensor in remote controller. 1: Suction (or level if DDC-controller connected. 00 = level 1 etc.) 2: Liquid pipe 3: Gas pipe</p> <p>Address data 8: Cool/heat group address 9: Demand / low noise address</p>	<p>Sensor data display</p> <p>Unit No. Sensor type</p> <p>1 1 41</p> <p>2 7 Temperature °C</p> <p>Address display</p> <p>Unit No. Address type</p> <p>1 8 41</p> <p>1 Address</p> <p>(VE008)</p>
43	Forced fan ON	<p>Manually turn the fan ON by each unit. (When you want to search for the unit No.)</p> <p>By selecting the unit No. with the button, you can turn the fan of each AHU on (forced ON) individually.</p>	<p>Unit 1</p> <p>43</p> <p>(VE009)</p>

Switching between Mode number 40-41-43 is done by pushing the up and down button. To return to normal operation: push the test button one time.

1.2. Wired remote controller BRC1/2/3E

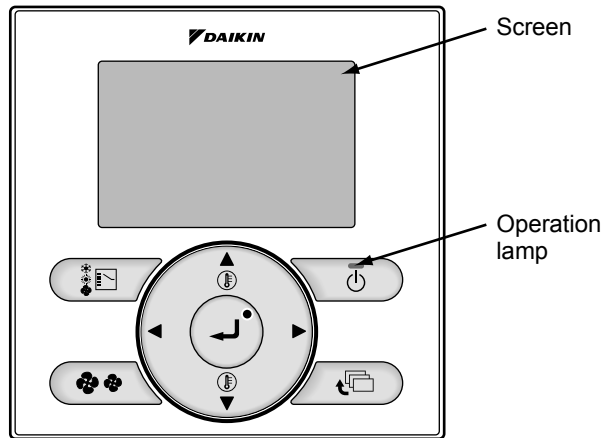

1.2.1. Access to error code

If operation stops due to malfunction, the remote controller's operation LED blinks, and malfunction code is displayed.

The malfunction code enables you to tell what kind of malfunction caused operation to stop.

	Operation Status	Display	
Abnormal shutdown	The system stops operating.	The operation lamp (green) starts to blink. The message "Error: Press Menu button" will appear and blink at the bottom of the screen.	
Warning	The system continues its operation.	The operation lamp (green) remains on. The message "Warning: Press Menu button" will appear and blink at the bottom of the screen.	

1.2.2. Access to service menu

When there is no error displayed but unit is behaving strangely, you can also check some more operational data in the Service menu.

How to access the Service menu:

- <Basic Screen>
- Operation mode changeover
 - Fan speed control
 - Menu display
 - Confirmation of each setting
 - On
 - Off
 - Cancel
 - Operation lamp

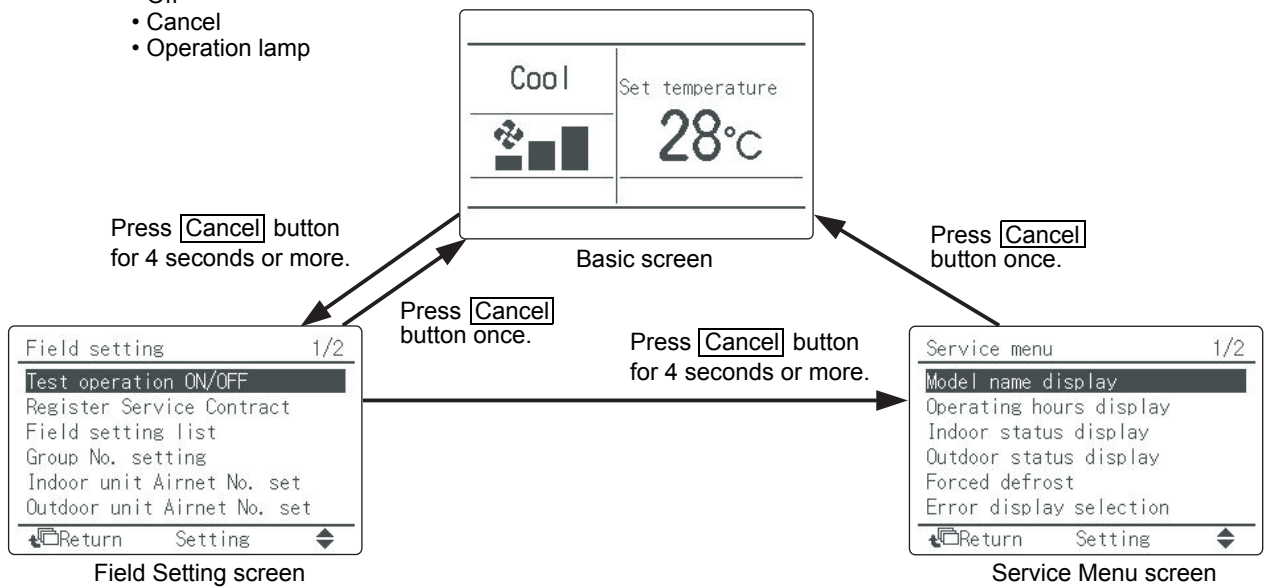

- <Field Setting Menu>
- Test operation ON/OFF
 - Register Service Contract
 - Field setting list
 - Group No. setting
 - Indoor unit AIRNET No. set
 - Outdoor unit AIRNET No. set
 - Error record
 - Indoor status display
 - Outdoor status display
 - Fan forced operation ON
 - Main/Sub changeover
 - Filter element sign OFF

- <Service Menu>
- Model name display
 - Operating hours display
 - Indoor status display
 - Outdoor status display
 - Forced defrost
 - Error display selection
 - Unit No. transfer
 - Sensor/address data display

Below items can be consulted in the Service Menu:

Service Menu	Item 2	Remarks
1. Model Name Display	1. Unit No.	Select the Unit No. you want to check.
	2. Indoor unit	
	3. Outdoor unit	
2. Operating Hours Display	1. Unit No.	Select the Unit No. you want to check.
	2. Indoor unit operating time	All of these are displayed in hours.
	3. Indoor unit fan operation	
	4. Indoor unit energized time	
	5. Outdoor operating time	
	6. Outdoor unit fan 1 operation	
	7. Outdoor unit fan 2 operation	
	8. Outdoor comp. 1 operation	
	9. Outdoor comp. 2 operation	
3. Indoor Status Display 1/2	1. Unit No.	
	2. FAN	Tap, speed (rpm)
	3. FLAP	Swing, fixed
	4. Speed	Fan speed (rpm)
	5. EV	Degree that electronic expansion valve is open (pls)
	6. MP	Drain pump ON/OFF
	7. 52H	Electric heater ON/OFF
	8. Hu	Humidifier ON/OFF
	9. Anti-freezing	Anti-freezing control ON/OFF
3. Indoor Status Display 2/2	1. Unit No.	Select the Unit No. you want to check.
		VRV
	2. Th1	Suction air thermistor
	3. Th2	Heat exchanger liquid pipe thermistor
	4. Th3	Heat exchanger gas pipe thermistor
	5. Th4	Discharge air thermistor
	6. Th5	—
7. Th6	—	
4. Outdoor Status Display	1. Unit No.	Select the Unit No. you want to check.
	2. FAN Tap 1	Fan tap
	3. COMP	Compressor power supply frequency (Hz)
	4. EV1	Degree that electronic expansion valve is open (pls)
	5. SV1	Solenoid valve ON/OFF
		VRV
	6. Th1	—
	7. Th2	—
8. Th3	—	
5. Error Display Selection	1. Warning display ON	Displays a warning on the screen if an error occurs.
	2. Warning display OFF	No warning is displayed.
	3. Error display ON	Displays the error on the screen.
	4. Error display OFF	Displays neither errors nor warnings.
6. Unit No. Transfer	1. Current Unit No.	A unit No. can be transferred to another.
	2. Transfer Unit No.	
7. Sensor Address Display	○ Unit No.: 0 - 15	Select the Unit No. you want to check.
	○ Code	
	00:	Remote controller thermistor (°C)
	01:	Suction air thermistor (°C)
	02:	Heat exchanger liquid pipe thermistor (°C)
	03:	Heat exchanger gas thermistor (°C)
	04:	Indoor unit address No.
	05:	Outdoor unit address No.
	06:	BS unit address No.
	07:	Zone control address No.
	08:	Cooling/heating batch address No.
09:	Demand/low-noise address No.	
○ Data	The corresponding data will be displayed, based on the Unit No. and Code selected.	

1.3. Wireless controller BRC4/7

1.3.1. Access to error code

If a unit stops due to an error, the operation indicating LED on indoor unit is blinking. The error code can be determined by following the procedure described below.

1	<p>Press the INSPECTION/TEST button to select "inspection". The equipment enters the inspection mode. The "Unit" indication is displayed and the Unit No. display shows blinking "0" indication.</p>	
2	<p>Set the Unit No. Press the UP or DOWN button and change the Unit No. display until the buzzer (*1) is generated from the indoor unit. *1 Number of beeps 3 short beeps: Conduct all of the following operations. 1 short beep: Conduct steps 3 and 4. Continue the operation in step 4 until a buzzer remains ON. The continuous buzzer indicates that the error code is confirmed. Continuous beep: No abnormality.</p>	
3	<p>Press the MODE selector button. The left "0" (upper digit) indication of the error code blinks.</p>	
4	<p>Error code upper digit diagnosis Press the UP or DOWN button and change the error code upper digit until the error code matching buzzer (*2) is generated.</p> <ul style="list-style-type: none"> The upper digit of the code changes as shown below when the UP and DOWN buttons are pressed. <div style="text-align: center;"> <p>⇒ "UP" button ← "DOWN" button</p> </div> <p>*2 Number of beeps Continuous beep: Both upper and lower digits matched. (Error code confirmed) 2 short beeps: Upper digit matched. 1 short beep: Lower digit matched.</p>	
5	<p>Press the MODE selector button. The right "0" (lower digit) indication of the error code blinks.</p>	
6	<p>Error code lower digit diagnosis Press the UP or DOWN button and change the error code lower digit until the continuous error code matching buzzer (*2) is generated.</p> <ul style="list-style-type: none"> The lower digit of the code changes as shown below when the UP and DOWN buttons are pressed. <div style="text-align: center;"> <p>⇒ "UP" button ← "DOWN" button</p> </div>	

No further information can be retrieved through the wireless controller BRC4/7.

2. Error code based troubleshooting

Error code					
Main	Sub	Status outdoor	Reset	Cause	Solution
A0	-	Thermo off O	Power off/on	Fault board	Check setting 22-1-3: T1-T2 NC. If correct, indoor board fault.
A1	-	Thermo off O	Power off/on	Fault Eeprom	Replace board.
A3	-	Cool thermo off	Auto recovery	Float switch open during thermo on (cooling)	Check float switch status, drain pipe no blockage, drain pipe raiser < 600 mm.
A6	01	Thermo off	BRC1..	Fan motor locked	Rpm counter no signal from motor to indoor main board when output.
	10	Thermo off	BRC1..	Fan motor overcurrent	Check motor power circuit. Replace fan motor / indoor board.
	11	Thermo off	BRC1..	Fan motor locked	Rpm counter no signal at off condition.
A7	-	Warning	BRC1.. Off/on	No detection contact swingmotor	Check swing motor run when output 230VAC. Check contact position detection open & close.
A9	01	Thermo off O	Power off/on	EV motor fault detection	Check signal board to expansion valve.
	02	Thermo off O	Power off/on	EV body leakage	Check temperature coil sensor at close EV cooling other indoor
AF		Thermo off	BRC1..	Float switch open during thermo off	Check for drain water returning from other indoor, expansion valve correct closing thermo off.
AH	03	Warning	BRC1..	Communication error main PCB / self cleaning PCB	Check wire harness connections.
	04	Warning	BRC1..	Dust detection sensor error	Check wire harness connections.
	05	Warning	BRC1..	Dust collection error	Check for clogging by dust between brush-arm and dust collector box.
	06	Warning	BRC1..	Air filter rotation error	Check rotation mechanism air filter.
	07	Warning	BRC1..	Damper rotation error	Check rotation mechanism damper.
	08	Warning	BRC1..	Filter cleaning time error	Filter auto cleaning program could not be performed 24 hr operation.
	09	Warning	BRC1..	Auto self cleaning disabled	Check field settings to enable auto filter cleaning.
AJ	01	Thermo off	Auto recovery	Capacity adaptor missing	Add corresponding capacity adaptor onto spare part PCB
	02	Thermo off	Power reset	Incorrect expansion valve motor	Use correct expansion valve motor (between gear type and direct drive).
C1	01	Thermo off	Auto recovery	Communication error main PCB / inverter PCB fan motor	Check for communication between main PCB and inverter PCB fan motor.
	02	Thermo off	Auto recovery	Communication error main PCB / auxiliary PCB	Check for communication between main PCB and inverter PCB fan motor.

<https://daikin-p.ru>

Error code					
Main	Sub	Status outdoor	Reset	Cause	Solution
C4	02	Thermo off	Auto recovery	Coil thermistor short circuit	Check coil thermistor resistance.
	03	Thermo off	Auto recovery	Coil thermistor open circuit	Check wire harness connections coil thermistor.
C5	02	Thermo off	Auto recovery	Gas thermistor short circuit	Check gas thermistor resistance.
	03	Thermo off	Auto recovery	Gas thermistor open circuit	Check wire harness connections gas thermistor.
C6	01	Thermo off	Auto recovery	Faulty combination main PCB - inverter PCB fan motor	Change inverter PCB fan motor correct type.
C9	02	Thermo off	Auto recovery	Air thermistor short circuit	Check air thermistor resistance.
	03	Thermo off	Auto recovery	Air thermistor open circuit	Check wire harness connections air thermistor.
CE	01	Thermo off	Auto recovery	No signal from optional presence sensor	Check wire harness connections
	02	Thermo off	Auto recovery	No signal from optional floor temperature sensor	Check wire harness connections
	03	Thermo off	Auto recovery	Faulty signal from optional floor temperature sensor	Check pins connector no short circuit
	04	Thermo off	Auto recovery	High temperature detection or electric noise floor temperature sensor	Check resistance floor temperature sensor
CJ	02	Thermo off	Auto recovery	Air thermistor BRC... short circuit	Check air thermistor BRC... resistance.
	03	Thermo off	Auto recovery	Gas thermistor open circuit	Check wire soldering air thermistor BRC... .
U4	01	Thermo off	Auto recovery	Communication error indoor - BS unit	Check communication between BS unit and indoor unit(s)
U9		Thermo off	Auto recovery	Communication error other indoor unit - BS unit	Check other indoor units with error other than U9
UA	13	Thermo off	Power reset	Indoor unit refrigerant type not compatible to outdoor unit	Change system lay out - remove this indoor unit from system
	15	Thermo off	Power reset	Outdoor unit is not compatible to self cleaning panel (up to VRVII)	Mount standard decoration panel
UE	-	Warning	Auto recovery	Communication error to central control device	Check communication indoor to central control Check existing group number set indoor Check registered group number central control.

<https://daikin-p.ru>

Part 3. Field settings





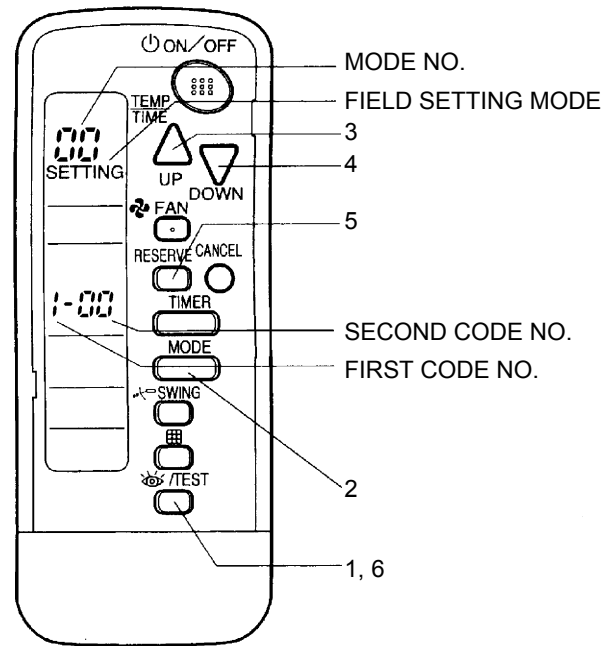

This part contains the following chapters:

1. Wireless remote controller BRC4C and BRC7C/E	21	7. Presence sensor BRYQ140A7 (for 3x3 cassette) / BRYQ60A7 (for 2x2 cassette).....	46
2. Wired remote controller BRC2/3E52	22	8. Selfcleaning panel BYCQ140D7G	47
3. Wired remote controller BRC1D51/52	27	9. Aircurtain CAV/CYV	48
4. Wired remote controller BRC1E51	30	10. VKM	48
5. Wired remote controller BRC1E52	35	11. FXSQ-A / FXNQ-A / FXDQ-A / FXMQ-P/MB / FXTQ-A	51
6. General indoor units.....	41	12. Factory settings.....	53

1. Wireless remote controller BRC4C and BRC7C/E

1.1. Access field settings



1. When in the normal mode, press the “  ” button for 4 seconds or more, and operation then enters the “field setting mode.”
2. Select the desired “mode No.” with the “  ” button.
3. Pressing the “  ” button, select the first code No.
4. Pressing the “  ” button, select the second code No.
5. Press the timer “  ” button and check the settings.
6. Press the “  ” button to return to the normal mode.

(Example)

When setting the filter sign time to “Filter contamination heavy/light” in all group unit setting, set the Mode No. to “10”, the first code No. to “0” and second code No. to “02”.

2. Wired remote controller BRC2/3E52

2.1. Access field settings



BRC2E52



BRC3E52

To enable the Menu/Enter and Cancel button (these are default disabled on these controllers) in the Basic screen, proceed as follow:

1. Keep the ► button pressed.
2. Push the 3 indicated keys simultaneously while keeping the ► button pressed.

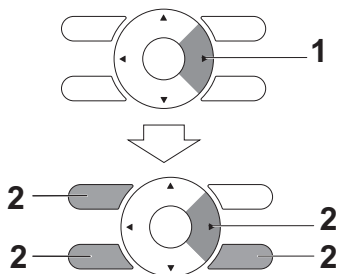

To disable the Menu/Enter and Cancel button in the Basic screen, follow the same procedure.

1. Enable the Menu/Enter and Cancel button. To enable, refer to [page 22](#).
2. Press and hold the Cancel button for 4 seconds or longer. The Service Settings menu is displayed.

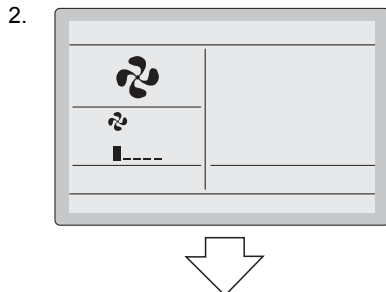

<Basic screen>

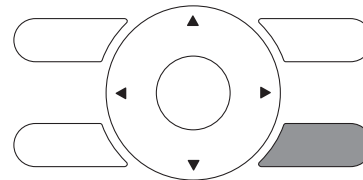

Press and hold the Cancel button for 4 seconds or longer while the backlight is lit.

3. Select Field Settings and press the Menu/Enter button.

<Service settings>

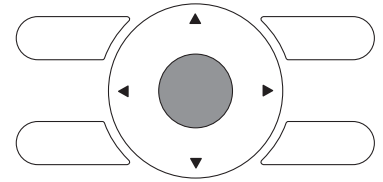
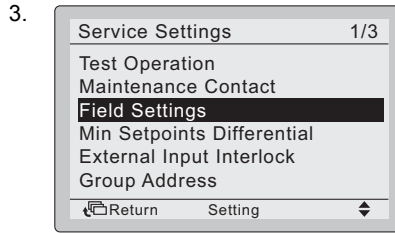

Press the Menu/Enter button.

4. Highlight the "Mode No.", and select the desired "Mode No." by using the ▲▼ (Up/Down) buttons. For the most commonly-used field settings, refer to page 25.

<Field settings>

In the case of individual setting per indoor unit

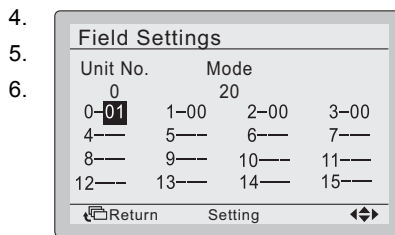

In the case of group setting

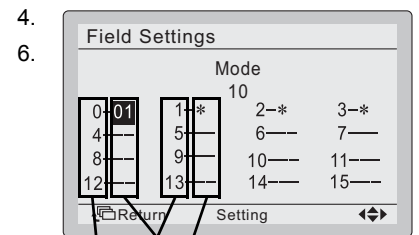

SECOND CODE NO.

FIRST CODE (SW) NO.

5. In the case of configuring the indoor units individually during group control (When Mode No. such as 20, 21, 22, 23, 25 are selected), highlight the unit No. and select the "Indoor unit Number" to be set by using the ▲▼ (Up/Down) buttons. (In the case of configuring as a group, this operation is not needed.)
6. Highlight the SECOND CODE NO. of the FIRST CODE NO. to be changed and select the desired SECOND CODE NO. by using the ▲▼ (Up/Down) buttons. Multiple identical mode number settings are available.

NOTE

- In the case of individual configuration per indoor unit, the current settings are displayed.
- SECOND CODE NO. " - " means that there is no function available
- In the case of configuring as a group, all SECOND CODE NO. which may be set are displayed as " * ".

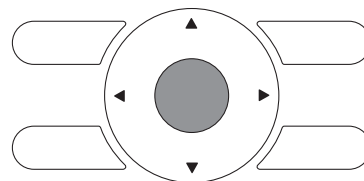

Press the Menu/Enter button.



7. Press the Menu/Enter button. The confirmation screen is displayed.
8. Select Yes and press the Menu/Enter button. The settings are saved and the Field settings screen returns.

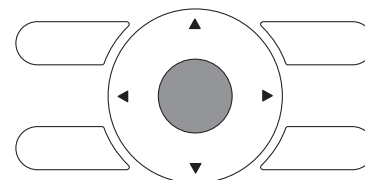
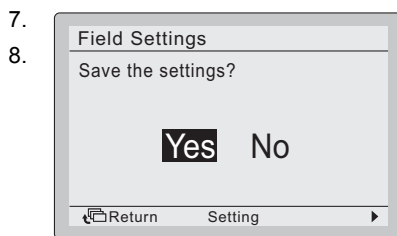

Press the Menu/Enter button.

<Field settings>

9. When multiple settings need to be changed, repeat step "3" to "8".
10. After all changes are completed, press the Cancel button twice.
11. The backlight goes out and "Checking the connection. Please stand by" is displayed during initialization. After the initialization, the Basic screen returns.
12. Disable the Menu/Enter and Cancel button when no other settings need to be changed. To disable, refer to [page 22](#).



CAUTION

- When an optional accessory is installed on the indoor unit, the settings of the indoor unit may be changed. See the manual of the optional accessory.
- For the details on the field settings of the indoor unit, see the installation manual attached to the indoor unit.
- The outdoor unit field settings can only be configured on the outdoor PCB. Refer to the installation manual attached to the outdoor unit.



NOTE

- Though the configuration is performed for the whole group, set the Mode No. in parenthesis when performing an individual configuration per indoor unit or when checking after the configuration is finished.
- The SECOND CODE NO. at factory shipment depends on the indoor unit model. Default values can be found in the respective Service Manual of the respective units.
For the following settings, the value is the same for all indoor units.
 - Thermostat sensor used for the "Auto" operation mode and the Setback function (room temperature on detailed display): "02".
 - Setback function: "04"
 - External input B1: "02"
 - External input B2: "02"
- Functions which are unavailable for the connected indoor unit(s) are not displayed.

2.2. Field settings, specific for wired remote controller BRC2/3E52





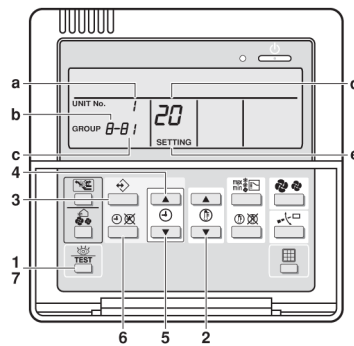

1b	4	error code detail	01	without details	ex. E3
			02	with details in field set & service mode	ex. E3-04
			03	with details in basic mode	ex. E3-04
			04	details in screen 'error code' and 'main screen'	ex. E3-04
	7	Display of symbol for defrost/hot start	01	on	
			02	off	
	8	automatic changeover winter-time-summertime	01	not active	
			02	automatic	
			03	manual	
			04	according to centralized control	
	11	Clock display in remote controller	01	Clock is shown in remocon	
			02	Clock is not shown in remocon	
	13	Display method	01	text (like BRC1E52)	
			02	symbols	
	14	number of flaps that can be blocked through setting	01	1	Only for FXFQ-A, FCQ(H)G-F: With this setting, you limit the choices in the menu. It is strongly advised not to use setting -02, -03, -04.
			02	2	
			03	3	
			04	4	
			05	none	
	15	Fan and swing setting	01	fanspeed and swing position can be set with remocon	
02			only fanspeed can be set with remocon		

1c	0	display of actual room temperature	01	off	
			02	on	
	1	selection air thermistor shown in room temp display	01	air return (R1T)	For auto-function & setback
			02	thermistor of BRC1E	
	2	Selection mode display in auto mode	01	off	Whether or not 'heating/cooling' is displayed during automatic mode (otherwise only 'automatic' is mentioned on remocon)
			02	on	
	4	backlight on	01	permanently off	Backlight goes off again after 20 seconds
			02	on for 30 seconds when pushing any button	
			03	always on	
	6	display of remocon	01	permanent display	the screen always shows values
			02	screen goes blank after 5 minutes	touching any button will reactivate the screen
	12	External input BC-B1 (window contact) of pcb board BRP7A51	01	don't use	
			02	use	
13	External input BC-B2 (keycard contact) of pcb board BRP7A51	01	don't use		
		02	use		
1e	1	enable temperature display in °C or °F	01	not visible	from factory locked to °C
			02	visible	visible in menu, choice between °C and °F
	2	"setback" - function	01	not available	Setback is home leave function
			02	available for heating	
			03	available for cooling	
			04	available for heating & cooling	
	5	hour indication	01	not visible in menu	default 24h is activated
			02	visible in menu	enduser can choose 24h or 12h display
	6	count down timer	01	not visible in menu	
			02	visible in menu	

3. Wired remote controller BRC1D51/52

3.1. Access field settings



1. When in the normal mode, press the “  ” button for a minimum of four seconds, and the FIELD SET MODE is entered.
2. Select the desired MODE NO. with the “  ” button.
3. During group control, when setting by each indoor unit (mode No. 20, 21, 22 and 23 have been selected), push the “  ” button and select the INDOOR UNIT NO. to be set. (This operation is unnecessary when setting by group.)
4. Push the “  ” upper button and select FIRST CODE NO.
5. Push the “  ” lower button and select the SECOND CODE NO.
6. Push the “  ” button once and the present settings are SET.
7. Push the “  ” button to return to the NORMAL MODE.

3.2. Field settings, specific for BRC1D51/52

Mode No. Note 1	FIRST CODE NO.	Description of setting		SECOND CODE NO. Note 2					
				01	02	03	04		
10(20)	0	Filter Contamination - Heavy/Light (Setting for spacing time of display time to clean air filter) (Setting for when filter contamination is heavy, and spacing time of display time to clean air filter is to be halved)	Ultra long life filter	Light	Approx. 10.000 hrs.	Heavy	Approx. 5.000 hrs.	-	-
			Long life filter		Approx. 2.500 hrs.		Approx. 1.250 hrs.		
			Standard filter		Approx. 200 hrs.		Approx. 100 hrs.		
	1	Long-life filter type (setting of filter sign indication time). (Change setting when ultra-long filter is installed)	Long-life filter	Ultra-long life filter	-	-			
2	Thermostat sensor in remote controller	Use	Not use	-	-				
3	Spacing time of display time to clean air filter count (setting for when the filter sign is not to be displayed)	Display	Do not display	-	-				
12(22)	1	ON/OFF input from outside (setting for when forced ON/OFF is to be operated from outside).	Forced OFF	ON/OFF operation	-	-			
	2	Thermostat differential changeover (setting for when using remote sensor).	1°C	0,5°C	-	-			
13(23)	0	High air outlet velocity (for high ceiling applications).	≤2,7 m	>2,7≤3,0 m	>3,0≤3,5 m	-			
	1	Selection of air flow direction (setting for when a blocking pad kit has been installed).	4-way flow	3-way flow	2-way flow	-			
	3	Selection of air flow function (setting for when using a decoration panel for outlet).	Equipped	Not equipped	-	-			
	4	Air flow direction range setting.	Upper	Normal	Lower	-			
	6	Setting the external static pressure (setting according to the connected duct resistance) (for FHYK, follow the high ceiling setting)	Normal (Normal)	High static pressure (High ceiling)	Low static pressure -	-			
15(25)	3	Drain pump operation with humidifying.	Equipped	Not equipped	-	-			
1b	0	Permission level setting	Level 2	Level 3	-	-			
	1	Leave home function	Not permitted	Permitted	-	-			
	2	Thermostat sensor in remote controller (for limit operation and leave home function only)	Use	Not use	-	-			

1b	0	user permission level (BRC1D)	01	level 2	available: on/off, temperature selection, delay, min/max operation, fanspeed, swingflap direction
			02	level 3	
1	setback function		01	not available	For setback function: After activation in mode 1b-1, push both buttons together to activate the function.
			02	available	
2	use of remocon sensor for 'limited' and 'setback' function		01	active	On the display the symbol will be visible.
			02	not active	
3	Start 'setback' - function		05	5°C	
			06	6°C	
			07	7°C	
			08	8°C	
			09	9°C	
			10	10°C	
			11	11°C	
			12	12°C	
			13	13°C	
			14	14°C	
			15	15°C	
4	Stop 'setback' - function		01	1K	
			02	2K	
			03	3K	
			04	4K	
			05	5K	
5	Usage of 'limited' function in combination with centralised control		01	not available	'limited' function = additional mode to permit keeping the temperature between a minimum and maximum value.
			02	available	

4. Wired remote controller BRC1E51

4.1. Access field settings



1. Press and hold Cancel button for 4 seconds or longer.
Service Settings menu is displayed.
2. Select Field settings in the Service Settings menu, and press Menu/Enter button.
Field settings screen is displayed.
3. Highlight the mode, and select desired "Mode No." by using ▲▼ (Up/Down) button.

<Basic screen>

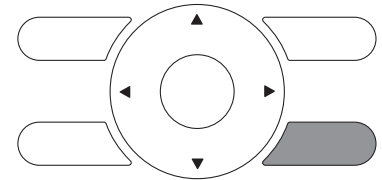
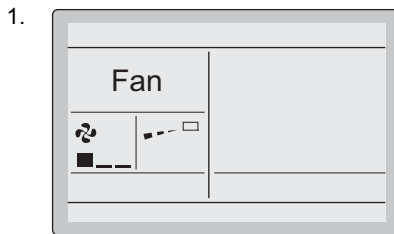

Press and hold Cancel button for 4 seconds or longer during backlight lit.

4. In the case of setting per indoor unit during group control (When Mode No. such as 20, 21, 22, 23, 25 are selected), highlight the unit No. and select "Indoor unit No." to be set by using ▲▼ (Up/Down) button. (In the case of group setting, this operation is not needed.) (In the case of individual setting per indoor unit, current settings are displayed. And, SECOND CODE NO. " - " means no function.)

<Service settings menu screen>

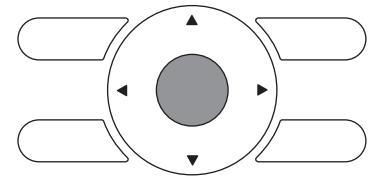
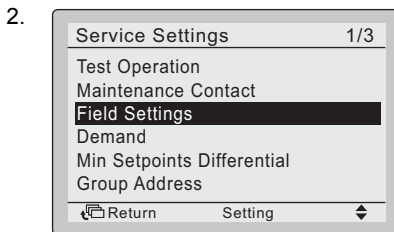

Press the Menu/Enter button.

- Highlight SECOND CODE NO. of the FIRST CODE NO. to be changed, and select desired "SECOND CODE NO." by using ▲▼ (Up/Down) button. Multiple identical mode number settings are available. (In the case of group setting, all of SECOND CODE NO. which may be set are displayed as "*" . "*" is changed to SECOND CODE NO. to be set. And, SECOND CODE NO. "-" means no function.)

<Field settings screen>

In the case of individual setting per indoor unit

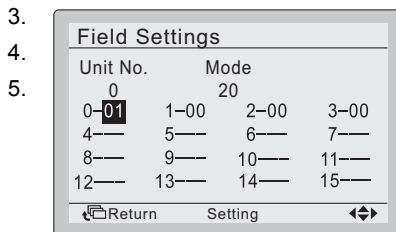

-
-
-
-
-

In the case of group setting

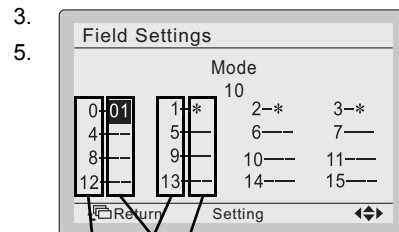

-
-
-
-
-

SECOND CODE NO.

FIRST CODE (SW) NO.

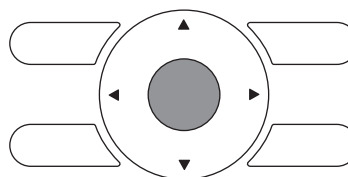

Press the Menu/Enter button.

- Press Menu/Enter button. Setting confirmation screen is displayed.
- Select Yes and press Menu/Enter button. Setting details are saved and Field settings screen returns.
- In the case of multiple setting changes, repeat step "3" to "7".
- After all setting changes are completed, press Cancel button twice.
- Backlight goes out, and "Checking the connection Please stand by" is displayed during initialization. After the initialization, the basic screen returns.

<Setting confirmation screen>

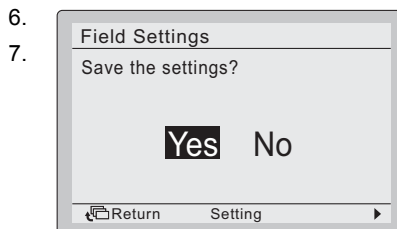

-
-
-
-
-
-
-

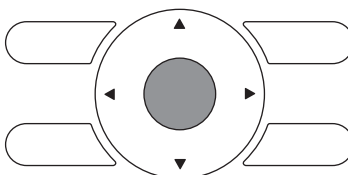

Press the Menu/Enter button.

Setting confirmation



CAUTION

- When an optional accessory is installed on the indoor unit, settings of the indoor unit may be changed. See the manual of the optional accessory.
- For field setting details of the outdoor unit, see installation manual attached to the outdoor unit.

4.2. Field settings, specific for BRC1E51

Mode No. Note 1	FIRST CODE NO.	Description of setting		SECOND CODE NO. Note 2					
				01	02	03	04		
10(20)	0	Filter Contamination - Heavy/Light (Setting for spacing time of display time to clean air filter) (Setting for when filter contamination is heavy, and spacing time of display time to clean air filter is to be halved)	Ultra long life filter	Light	Approx. 10.000 hrs.	Heavy	Approx. 5.000 hrs.	-	-
			Long life filter		Approx. 2.500 hrs.		Approx. 1.250 hrs.		
			Standard filter		Approx. 200 hrs.		Approx. 100 hrs.		
	1	Long-life filter type (setting of filter sign indication time). (Change setting when ultra-long filter is installed)	Long-life filter	Ultra-long life filter	-	-			
2	Thermostat sensor in remote controller	Use	Not use	-	-				
3	Spacing time of display time to clean air filter count (setting for when the filter sign is not to be displayed)	Display	Do not display	-	-				
12(22)	1	ON/OFF input from outside (setting for when forced ON/OFF is to be operated from outside).	Forced OFF	ON/OFF operation	-	-			
	2	Thermostat differential changeover (setting for when using remote sensor).	1°C	0,5°C	-	-			
13(23)	0	High air outlet velocity (for high ceiling applications).	≤2,7 m	>2,7≥3,0 m	>3,0≥3,5 m	-			
	1	Selection of air flow direction (setting for when a blocking pad kit has been installed).	4-way flow	3-way flow	2-way flow	-			
	3	Selection of air flow function (setting for when using a decoration panel for outlet).	Equipped	Not equipped	-	-			
	4	Air flow direction range setting.	Upper	Normal	Lower	-			
	6	Setting the external static pressure (setting according to the connected duct resistance) (for FHYK, follow the high ceiling setting)	Normal (Normal)	High static pressure (High ceiling)	Low static pressure -	-			
15(25)	3	Drain pump operation with humidifying.	Equipped	Not equipped	-	-			
1c	1	Thermostat sensor in remote controller (for limit operation and Home leave function only)	Not use	Use	-	-			
	3	Permission level setting	Level 2	Level 3	-	-			
1e	2	Home leave function	Not permitted	Permitted	-	-			



NOTE

- Though setting is performed totally in the group, set Mode No. in the parenthesis when individual setting per indoor unit or checking after the setting should be performed.
- SECOND CODE NO. at factory shipment is set to "01". However for the following cases it is set to "02".
 - Airflow direction range setting (except round flow cassette)
 - Thermostat sensor in remote controller (Sky Air only)
 - Thermostat sensor in remote controller for limit operation and Home leave function only
- Any function which the indoor unit does not have is not displayed.

1b	4	error code detail	01	without details	ex. E3
			02	with details in field set & service mode	ex. E3-04
			03	with details in basic mode	ex. E3-04
			04	details in screen 'error code' and 'main screen'	ex. E3-04
	7	Display of symbol for defrost/hot start	01	on	
			02	off	
	8	automatic changeover winter-time-summertime	01	not active	
			02	automatic	
			03	manual	
			04	according to centralized control	
a	OFF-reminder timer	01	not visible		
		02	visible		
1c	0	display of actual room temperature	01	off	
			02	on	
	1	selection air thermistor shown in room temp display	01	air return (R1T)	For auto-function & setback
			02	thermistor of BRC1E	
	2	Selection mode display in auto mode	01	off	Whether or not 'heating/cooling' is displayed during automatic mode (otherwise only 'automatic' is mentioned on remocon)
			02	on	
	3	Permission level setting	01	level 2 (low, high; on/off; operation mode)	
			02	level 3 (on/off)	
	4	backlight on	01	permanently off	
			02	on for 30 seconds when pushing any button	
			03	always on	
	5	operation when backlight is off	01	no	when pushing a button, first backlight is activated, function of button is not activated
			02	yes	when pushing a button, backlight is activated and immediately function of button is activated
	6	display of remocon	01	permanent display	the screen always shows values
			02	screen goes blank after 5 minutes	touching any button will reactivate the screen
	A	Setback cooling differential	01	-	Home leave function requires that room temperature doesn't rise above a certain temperature when there is nobody home. If ambient temperature rises above 34°C, cooling will automatically start until 29°C (default differential of 5°C) is reached, then unit goes back to its original state.
			02	-2°C	
			03	-3°C	
			04	-4°C	
05			-5°C		
06			-6°C		
07			-7°C		
08			-8°C		
09			-9°C		
B	Setback heating differential	01	-	Home leave function requires that room temperature doesn't drop below a certain temperature when there is nobody home. If ambient temperature drops below 14°C, heating will automatically start until 19°C (default differential of 5°C) is reached, then unit goes back to its original state.	
		02	+2°C		
		03	+3°C		
		04	+4°C		
		05	+5°C		
		06	+6°C		
		07	+7°C		
		08	+8°C		
		09	+9°C		

1e	0	"set temp mode changeover" visibility in main menu	01	visible	
			02	hide from main menu	
	1	enable temperature display in °C or °F	01	not visible	from factory locked to °C
			02	visible	visible in menu, choice between °C and °F
	2	"setback" - function	01	not available	Setback is home leave function
			02	available	
	3	selection set temperature in limit operation when power on/off	01	not keep	
			02	keep	
	4	timer setting: when centralized control (similar to BRC1D528 setting 1b-5)	01	not visible	to avoid conflict between timer inside centralized remocon and BRC1E
			02	visible	
	5	hour indication	01	not visible in menu	default 24h is activated
			02	visible in menu	enduser can choose 24h or 12h display
	6	count down timer	01	not visible in menu	
			02	visible in menu	
	A	Offset for master remocon sensor	01	-3°C	with this setting it's possible to modify the readout by remocon of the ambient temperature
			02	-2,5°C	
			03	-2°C	
			04	-1,5°C	
			05	-1°C	
			06	-0,5°C	
07			0°C		
08			+0,5°C		
09			+1°C		
B	offset for slave remocon sensor	01	-3°C	with this setting it's possible to modify the readout of ambient temperature of the secondary remocon	
		02	-2,5°C		
		03	-2°C		
		04	-1,5°C		
		05	-1°C		
		06	-0,5°C		
		07	0°C		
		08	+0,5°C		
		09	+1°C		

5. Wired remote controller BRC1E52

5.1. Access field settings



1. Press and hold Cancel button for 4 seconds or longer. Service Settings menu is displayed.
2. Select Field settings in the Service Settings menu, and press Menu/Enter button. Field settings screen is displayed.
3. Highlight the mode, and select desired "Mode No." by using ▲▼ (Up/Down) button.

<Basic screen>

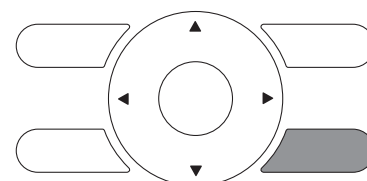
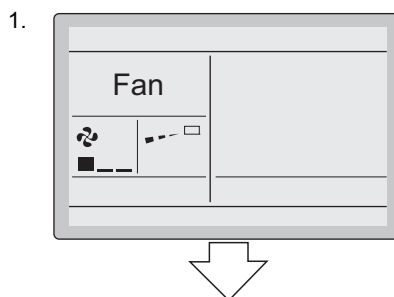

Press and hold Cancel button for 4 seconds or longer during backlight lit.

4. In the case of setting per indoor unit during group control (When Mode No. such as 20, 21, 22, 23, 25 are selected), highlight the unit No. and select "Indoor unit No." to be set by using ▲▼ (Up/Down) button. (In the case of group setting, this operation is not needed.) (In the case of individual setting per indoor unit, current settings are displayed. And, SECOND CODE NO. " - " means no function.)

<Service settings menu screen>

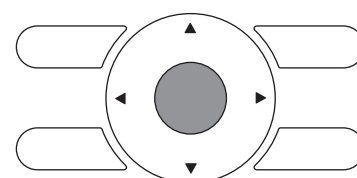
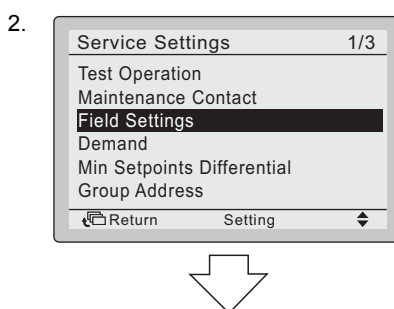

Press the Menu/Enter button.

5. Highlight SECOND CODE NO. of the FIRST CODE NO. to be changed, and select desired "SECOND CODE NO." by using ▲▼ (Up/Down) button.
Multiple identical mode number settings are available.
(In the case of group setting, all of SECOND CODE NO. which may be set are displayed as "*". "*" is changed to SECOND CODE NO. to be set. And, SECOND CODE NO. "-" means no function.)

<Field settings screen>

In the case of individual setting per indoor unit

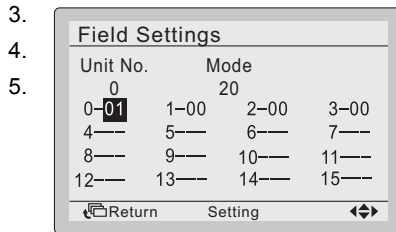

In the case of group setting

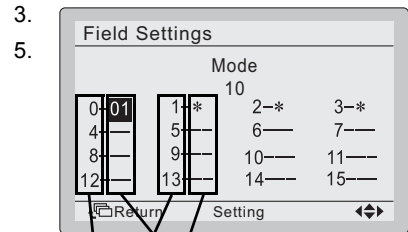

SECOND CODE NO.

FIRST CODE (SW) NO.

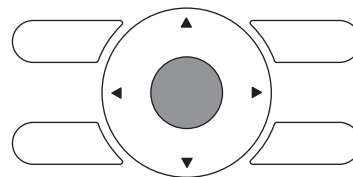

Press the Menu/Enter button.

6. Press Menu/Enter button. Setting confirmation screen is displayed.
7. Select Yes and press Menu/Enter button. Setting details are saved and Field settings screen returns.
8. In the case of multiple setting changes, repeat step "3" to "7".
9. After all setting changes are completed, press Cancel button twice.
10. Backlight goes out, and "Checking the connection Please stand by" is displayed during initialization. After the initialization, the basic screen returns.

<Setting confirmation screen>

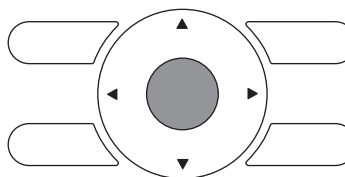
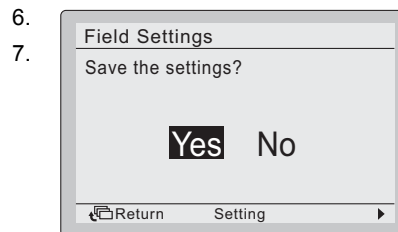

Press the Menu/Enter button.

Setting confirmation



CAUTION

- When an optional accessory is installed on the indoor unit, settings of the indoor unit may be changed. See the manual of the optional accessory.
- For field setting details of the outdoor unit, see installation manual attached to the outdoor unit.

5.2. Field settings, specific for BRC1E52

Mode No. Note 1	FIRST CODE NO.	Description of setting	SECOND CODE NO. Note 2						
			01	02	03	04			
10(20)	0	Filter Contamination - Heavy/Light (Setting for spacing time of display time to clean air filter) (Setting for when filter contamination is heavy, and spacing time of display time to clean air filter is to be halved)	Ultra long life filter	Light	Approx. 10.000 hrs.	Heavy	Approx. 5.000 hrs.	-	-
			Long life filter		Approx. 2.500 hrs.		Approx. 1.250 hrs.		
			Standard filter		Approx. 200 hrs.		Approx. 100 hrs.		
	1	Long-life filter type (setting of filter sign indication time). (Change setting when ultra-long filter is installed)	Long-life filter	Ultra-long life filter	-	-			
	2	Thermostat sensor in remote controller	Use	Not use	-	-			
	3	Spacing time of display time to clean air filter count (setting for when the filter sign is not to be displayed)	Display	Do not display	-	-			
12(22)	1	ON/OFF input from outside (setting for when forced ON/OFF is to be operated from outside).	Forced OFF	ON/OFF operation	-	-			
	2	Thermostat differential changeover (setting for when using remote sensor).	1°C	0,5°C	-	-			
13(23)	0	High air outlet velocity (for high ceiling applications).	≤2,7 m	>2,7≥3,0 m	>3,0≥3,5 m	-			
	1	Selection of air flow direction (setting for when a blocking pad kit has been installed).	4-way flow	3-way flow	2-way flow	-			
	3	Selection of air flow function (setting for when using a decoration panel for outlet).	Equipped	Not equipped	-	-			
	4	Air flow direction range setting.	Upper	Normal	Lower	-			
	6	Setting the external static pressure (setting according to the connected duct resistance) (for FHYK, follow the high ceiling setting)	Normal (Normal)	High static pressure (High ceiling)	Low static pressure -	-			
15(25)	3	Drain pump operation with humidifying.	Equipped	Not equipped	-	-			
1c	1	Thermostat sensor in remote controller (for Auto mode and Setback function only)	Not use	Use	-	-			
1e	2	Setback function	Not use	Heat only	Cool only	Cool and Heat			



NOTE

- Though setting is performed totally in the group, set Mode No. in the parenthesis when individual setting per indoor unit or checking after the setting should be performed.
- SECOND CODE NO. at factory shipment is set to "01". However for the following cases it is set to "02".
 - Airflow direction range setting (except round flow cassette)
 - Thermostat sensor in remote controller (Sky Air only)
 - Thermostat sensor in remote controller for auto mode operation and Setback function only
- Any function which the indoor unit does not have is not displayed.

1b	0	quiet mode display	01	visible in menu	Whether or not the quiet mode can be selected in the menu
			02	not visible in menu	
	4	error code detail	01	without details	ex. E3
			02	with details in field set & service mode	ex. E3-04
			03	with details in basic mode	ex. E3-04
			04	details in screen 'error code' and 'main screen'	ex. E3-04
	7	Display of symbol for defrost/hot start	01	on	Whether or not the defrost/hot start symbol is displayed on the remocon screen
			02	off	
	8	automatic changeover winter-time-summertime	01	not active	
			02	automatic	
			03	manual	
			04	according to centralized control	
	11	Clock display	01	active	Whether or not the clock is displayed on the remocon screen
			02	not active	
	14	FXFQ-A, FCQ(H)G-F: number of flaps that can be blocked	01	1	With this setting, you limit the choices in the menu. It is strongly advised not to use setting -02, -03, -04.
			02	2	
			03	3	
			04	4	
			05	none	

1c	0	display of actual room temperature	01	off	
			02	on	
1	1	selection air thermistor shown in room temp display (for auto mode and setback function only)	01	air return (R1T)	For auto-function & setback
			02	thermistor of BRC1E	
2	2	Visualisation of mode display on remocon in auto mode	01	off	Whether or not 'heating/cooling' is displayed during automatic mode (otherwise only 'automatic' is mentioned on remocon)
			02	on	
3	3	disable level	01	level 2 (low, high; on/off; operation mode)	
			02	level 3 (on/off)	
4	4	backlight on	01	permanently off	
			02	on for 30 seconds when pushing any button	
			03	always on	
5	5	operation when backlight is off	01	no	when pushing a button, first backlight is activated, function of button is not activated
			02	yes	when pushing a button, backlight is activated and immediately function of button is activated
6	6	display of remocon	01	permanent display	the screen always shows values
			02	screen goes blank after 5 minutes	touching any button will reactivate the screen
9	9	Sensor selection if 2 remocon	01	main controller	temperature sensor of main controller is used for ambient (in case 1c-1-2)
			02	2nd controller	temperature sensor of 2nd controller is used for ambient (in case 1c-1-2)
10	10	Offset master remocon sensor	01	-3°C	to modify displayed temperature on remocon 1
			02	-2,5°C	
			03	-2°C	
			04	-1,5°C	
			05	-1°C	
			06	-0,5°C	
			07	0°C	
			08	+0,5°C	
			09	+1°C	
11	11	Offset slave remocon sensor	01	-3°C	to modify displayed temperature on remocon 2
			02	-2,5°C	
			03	-2°C	
			04	-1,5°C	
			05	-1°C	
			06	-0,5°C	
			07	0°C	
			08	+0,5°C	
			09	+1°C	

1e	0	"set temp mode changeover" visibility in main menu	01	visible	
			02	hide from main menu	
	1	enable temperature display in °C or °F	01	not visible in menu	from factory locked to °C
			02	visible in menu	visible in menu, choice between °C and °F
	2	Setback function	01	not available	
			02	available for heating	
			03	available for cooling	
			04	available for heating & cooling	
	4	timer setting: when centralized control (similar to BRC1D528 setting 1b-5)	01	not visible	to avoid conflict between timer inside centralized remocon and BRC1E
			02	visible	
	5	hour indication	01	not visible in menu	default 24h is activated
			02	visible in menu	enduser can choose 24h or 12h display
	6	count down timer	01	not visible in menu	
			02	visible in menu	
	9	Display of 'change-over' and 'centralised' symbols	01	not visible on remocon	whether or not the 'arrows' symbol is visible on the remocon
			02	visible in remocon	
	10	Display of info on remocon when activating prohibited function which is locked through centralised control	01	show key-symbol	
			02	show message	
	11	switching delay in automatic mode	01	15 min	
02			30 min		
03			60 min		
04			90 min		

6. General indoor units

These settings are applicable to most of the indoor units.

10 / 20	0	Filter contamination (time between 2 filter cleaning display indications)	01	light	Ultra-long life Filter: +/-10.000 hrs Long-life filter +/-2.500 hrs Standard filter +/-200 hrs
			02	heavy	Ultra-long life Filter: +/-5.000 hrs Long-life filter +/-1.250 hrs Standard filter +/-100 hrs
	1	Long life filter type	01	long life filter	Filterclass G1
			02	super long life filter (option)	Filter type F6 high efficiency 64 for FXCQ-FXUQ-FXFQ-FXZQ-FXKQ-FXSQ-FXDQ-FXFQ-FXMQ Filter type F7 for VAM (additional filter) Filter type F8 very high efficiency 90 for FXCQ-FXFQ-FXSQ-FXMQ
			04	oil guard filter	for installations in greasy environment
	2	Indoor thermostat sensor selection (no effect when used in conjunction with presence sensor BRYQ)	01	Use both the unit sensor (or remote sensor if installed) AND the remote controller sensor.	Note: If setting 10-6-02 + 10-2-01 or 10-2-02 or 10-2-03 are set at the same time, then setting 10-2-01, 10-2-02 or 10-2-03 have priority. Note: If setting 10-6-01 + 10-2-01 or 10-2-02 or 10-2-03 are set at the same time, then setting for group connection, 10-6-01 has priority and for individual connection, 10-2-01, 10-2-02 or 10-2-03 have priority.
			02	Use return air sensor only (or remote sensor if installed).	Note: If setting 10-6-02 + 10-2-01 or 10-2-02 or 10-2-03 are set at the same time, then setting 10-2-01, 10-2-02 or 10-2-03 have priority. Note: If setting 10-6-01 + 10-2-01 or 10-2-02 or 10-2-03 are set at the same time, then setting for group connection, 10-6-01 has priority and for individual connection, 10-2-01, 10-2-02 or 10-2-03 have priority.
			03	Use remote controller sensor only.	Note: If setting 10-6-02 + 10-2-01 or 10-2-02 or 10-2-03 are set at the same time, then setting 10-2-01, 10-2-02 or 10-2-03 have priority. Note: If setting 10-6-01 + 10-2-01 or 10-2-02 or 10-2-03 are set at the same time, then setting for group connection, 10-6-01 has priority and for individual connection, 10-2-01, 10-2-02 or 10-2-03 have priority.
	3	Filter sign display	01	Display	
			02	Do not display	
5	Remote controller thermistor visible by central control device in group wiring P1P2	01	no		
		02	yes		
6	Air thermistor selection in group wiring P1P2	01	return air thermistor (individual units)		
		02	Thermistor designated by fieldsetting 20-2		
7	Absence delay detecting time (presence sensor)	01	30 minutes		
		02	60 minutes		
8	Compensation air sensor heating	01	add 2°C to measurement air sensor		
		02	measurement air sensor		

11 / 21	3	Fan setting of heating	01	standard	
			02	slight increase	
			03	increase	
	6	Sensitivity presence sensor	01	high sensitive	for BRYQ140A7 / BRYQ60A
			02	low sensitive	
			03	standard	
			04	disable presence sensor	
	7	External static pressure setting: Automatic airflow adjustment function	01	airflow adjustment is OFF (manual setting 23-6)	For FXSQ-FXMQ 1. Turn off the indoor unit 2. Set indoor unit to fan operation mode. 3. Choose desired fanspeed (L,H,HH) 4. Change setting 21-7-00 to 21-7-03 and exit setting menu 5. Activate indoor unit to start the learning function 6. Learn
			02	Completion of automatic airflow adjustment	
			03	Start of automatic airflow adjustment	
	8	Compensation by floor sensor	01	floor sensor disabled	for BRYQ140A7 / BRYQ60A
			02	air suction temperature priority	
			03	standard	
			04	floor temperature priority	
	9	Compensation by floor temperature	01	-4°C	for BRYQ140A7 / BRYQ60A
			02	-2°C	
03			no correction		
04			+2°C		

12 / 22	0	Output signal X1-X2 of the optional KRP1B PCB kit	01	indoor unit turned ON by thermostat	
			02	--	
			03	operation output	
			04	malfunction output	
	1	External ON/OFF (T1/T2 input) = setting when forced ON/OFF is operated from outside.	01	forced off	
			02	ON/OFF operation	
			03	external protection device input	
			04	forced OFF - multi tenant	
	2	Thermostat differential changeover (set when remote sensor is to be used)	01	1°C	FXFQ, FXZQ, FXCQ, FXKQ, FXUQ, FXHQ, VKM, "biddle"
			02	0,5°C	FXSQ, FXMQ, FXAQ, FXLQ, FXNQ, FXDQ, EKEQM
	3	Fanspeed setting during thermostat OFF at heating operation	01	LL	
			02	Set speed	
			03	OFF	Note: only use in combination with optional remote sensor or when setting 10-2-03 is used.
	4	Differential for automatic changeover. Temperature difference between cooling setpoint and heating setpoint in automatic mode. Differential is cooling setpoint minus heating setpoint.	01	0°C (hp)	ex: cooling 24°C/Heating 24°C
			02	1°C	ex: cooling 24°C/Heating 23°C
			03	2°C	ex: cooling 24°C/Heating 22°C
			04	3°C (HR)	ex: cooling 24°C/Heating 21°C
			05	4°C (VKM)	ex: cooling 24°C/Heating 20°C
			06	5°C	ex: cooling 24°C/Heating 19°C
			07	6°C	ex: cooling 24°C/Heating 18°C
			08	7°C	ex: cooling 24°C/Heating 17°C
	5	Auto-restart after power failure	01	disabled	
02			enabled		
6	Fan setting during thermostat OFF at cooling operation	01	very low speed		
		02	according to remocon setting		
		03	ventilation off		
9	Forced cool/heat master	01	disabled (select by cool/heat selection button controller)	only for 2 pipe heatpump VRV systems	
		02	enabled (not possible by cool/heat selection button controller)		

13 / 23	0	Airflow amount setting (Ceiling height)	01	normal ceiling (<2,7m)	Depends on indoor unit
			02	slightly higher ceiling (2,7m)	
			03	high ceiling (3m)	
	1	selection of airflow direction (set when a blocking path kit has been installed, 4-way blow panel)	01	4 way directions	Note: freeze-up protection will come in when the temperature, measured by R2T is below -1°C for 10 minutes.
			02	3 way directions	Note: freeze-up protection will come in when the temperature, measured by R2T is below 0°C for 1 minute or below 1°C for 15 minutes.
			03	2 way directions	
	2	Swing pattern setting if 4 swing motors	01	all directions simultaneously swing	
			02	--	
			03	opposite sides synchronization swing	
	3	Output to flap motor	01	enabled	
			02	disabled	
			03	--	
	4	Setting of airflow direction adjustment range	01	draft prevention	high position (10-40°)
			02	standard	standard position (10-65°)
			03	ceiling soiling prevention	low position (30-65°)
	5	fanspeed setting	01	Standard	for FXFQ-M, FXHQ-M & FXZQ-M
			02	Low	
			03	Low	
		Setting the static pressure selection	01	Standard (10/15Pa)	for FXDQ-A & FXNQ-A
			02	High static pressure (30/44Pa)	
			03	Medium static pressure	
			04	Medium static pressure	
		6	External static pressure settings	01	30 Pa
02	50 Pa			for FXSQ-P/A, FXMQ-P, FXTQ-A ESP value based on nominal airflow rate = Hhspeed	
03	60 Pa				
04	70 Pa				
05	80 Pa				
06	90 Pa				
07	100 Pa				
08	110 Pa				
09	120 Pa				
10	130 Pa				
11	140 Pa				
12	150 Pa				
13	160 Pa				
14	180 Pa				only for FXMQ 50 - 125 PVE
15	200 Pa				
7	Thermostat swing	01	equipped		
		02	not equipped		

14 / 24	2	when to display cleaning requirement on the remote control according to number of operating hours	01	Display after 1.250h	only for BYCQ
			02	Display after 2.500h	
			03	Display after 5.000h	
	3	Display filter change on the remote control according to number of operating hours	01	no display	
			02	display after 32.000h	
			03	display after 48.000h	
			04	display after 72.000h	
	4	Panel indicator (green)	01	On while in a/c operation & filter cleaning operation	
			02	possible to turn on while in filter cleaning operation only	
			03	off while in a/c operation and filter cleaning operation	
			04	On	
	8	auto cleaning program	01	choice between auto and schedule	
02			only schedule (auto not in menu)		
9	Dust amount setting	01	standard		
		02	dust amount big		
15 / 25	0	Drainpump operation (for units equipped with drainpump 13VDC)	01	stop for 5 minutes when thermo off	
			02	stop permanently during thermo off	
		Air cleaner	01	not equipped	
			02	equipped	
	1	Humidification during thermo off (heating)	01	Off	
			02	On	
	2	Direct duct connection (ex. Fresh air connection) to indoor	01	none	
			02	equipped	Fan must be operated from indoor unit
	3	Drain pump operation if humidifier is used (heating)	01	not equipped	
			02	equipped	
	4	Filter sign	01	by timer	
			02	by external input	
	9	Demand control	01	not equipped	
			02	equipped	

7. Presence sensor BRYQ140A7 (for 3x3 cassette) / BRYQ60A7 (for 2x2 cassette)



21	3	(for BRYQ60A7) Fanspeed setting during heating operation	01	don't speed up (correction factor 1,00)
			02	speed up by 5% (correction factor 1,05)
			03	speed up by 10% (correction factor 1,10)
	6	Sensitivity presence sensor	01	high sensitive
			02	low sensitive
			03	standard
			04	disable presence sensor
	8	Compensation by floor sensor	01	floor sensor disabled
			02	air suction temperature priority
			03	standard
			04	floor temperature priority
	9	Compensation by floor temperature	01	-4°C
			02	-2°C
			03	no correction
			04	+2°C
	23	1	(for BRYQ60A7) Select airflow direction	01
02				3-way direction

8. Selfcleaning panel BYCQ140D7G

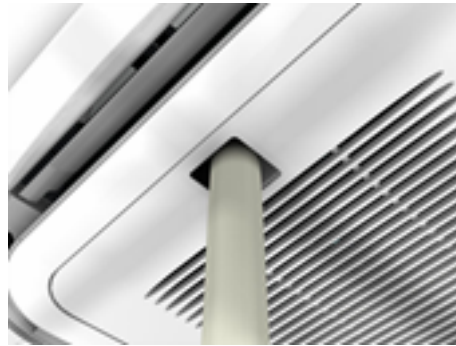

14/24	2	when to display cleaning requirement on the remote control according to number of operating hours	01	Display after 1.250h
			02	Display after 2.500h
			03	Display after 5.000h
	3	Display filter change on the remote control according to number of operating hours	01	no display
			02	Display after 32.000h
			03	Display after 48.000h
			04	Display after 72.000h
	4	Panel indicator (green)	01	On while in a/c operation and filter cleaning operation
			02	possible to turn on while in filter cleaning operation only
			03	off while in a/c operation and filter cleaning operation
			04	On
	8	auto cleaning program	01	choice between auto and schedule
02			only schedule (auto not in menu)	
9	Dust amount setting	01	standard	
		02	dust amount big	

DIP-switches on PCB

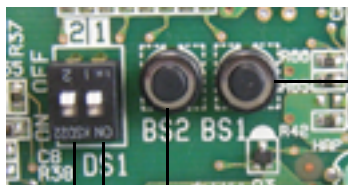

- BS1 → Cleaning test
Push for 1 second to start the cleaning test
- BS2 → Error reset
Push for 1 second to reset an error
- DIP DS1 – 1 → Self-cleaning available / unavailable
ON - not available
OFF - available
- DIP DS1 – 2 → Light intensity of the infrared sensor
ON - high
OFF - normal

9. Aircurtain CAV/CYV



14/ 24	6	Fan switching delay at hotstart in minutes	01	0 minutes (fan starts immediately)
			02	1 minute
			03	3 minutes (default)
			04	5 minutes
	7	Fan switching delay for hotstart in °C depending on the condensing pressure	01	34°C
			02	37°C
			03	40°C
			04	43°C (default)
	8	Fan speed during defrosting or oil return	01	Fan off
			02	Fan LL (default)
			03	Keep fanspeed

10. VKM



15/ 25	5	independent ventilation	01	not equipped
			02	equipped
	6	independent unit	01	no
			02	yes

17 / 27	0	Interval time for filter sign indication	01	2500 hours			
			02	1250 hours			
			03	no counting			
	1	Nighttime free cooling operation setting		01	no free cooling possible	Free cooling starts when outdoor temperature is below ambient temperature and when minimum stop-time has expired. Ambient temperature is checked 1x per hour. (combination with setting 27/6 & 27/7)	
				02	free cooling 2 hours after unit stop		
				03	free cooling 4 hours after unit stop		
				04	free cooling 6 hours after unit stop		
				05	free cooling 8 hours after unit stop		
	4	fan speed initial setting		01	normal	possibility to use SS1 on pcb of VKM	
				02	Ultra high		
	5	Direct duct connection with VRV indoor		01	not direct duct (airflow setting)	VKM works independent of indoor units	
				02	with direct duct (fan off)	the fan of the VKM stops immediately when indoor unit fan stops (thermo off, defrost, oil return and hot start)	
				03	-		
				04	no direct duct (airflow setting)	the fan of VKM goes to low speed when the fan of indoor unit stops (thermo off, defrost, oil return and hot start)	
				05	-		
				06	with direct duct (fan off)	the fan of VKM goes to low speed when the indoor fan stops (thermo off, defrost, oil return and hot start)	
				07			
				08	no direct duct (fan off)		
		Cold areas: Fan speed setting			01	Keep set fanspeed	In case independent operation, set fanspeed in thermo off, defrost & oil return
					02	Heating Th off: set fanspeed Defrost: stop Oil return: stop	
					03	-	
					04	Heating Th off: low Defrost: stop Oil return: stop	
					05	-	
06					Heating Th off: low Defrost: stop Oil return: stop		
07							
08	Heating Th off: set fanspeed Defrost: stop Oil return: stop						
6	Ventilation airflow setting when nighttime free cooling setting		01	High			
			02	Ultra high			

18 / 28	4	Display for ventilation mode	01	show	
			02	hide	
	7	Fresh up air supply/exhaust setting	01	no indication supply	
			02	no indication exhaust	
			03	indication supply	
			04	indication exhaust	
	8	External input terminal function selection (between J1 & JC)	01	fresh-up	fresh up operation
			02	overall alarm	malfunction code 60 is displayed
			03		
			04		
			05		
			06	airflow increase	fan strengthen up (low to high, high to ultra-high)
9	KRP50-2 output switching selection (between 1 & 3)	01	fan on/off		
		02	abnormal		
19 / 29	0	ventilation airflow setting	01	low	
			02	low	
			03	low	
			04	low	
			05	high	
			06	high	
	2	Ventilation mode setting	01	Automatic	
			02	Exchange	
			03	Bypass	
	1A	0	fresh-up operation	01	not active
02				active	

<https://daikin-p.ru>

11. FXSQ-A / FXNQ-A / FXDQ-A / FXMQ-P/MB / FXTQ-A

FXSQ-A



FXMQ-P/MB



FXNQ-A

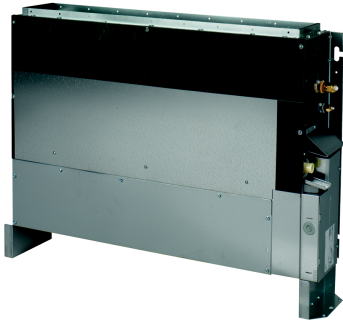

FXTQ-A

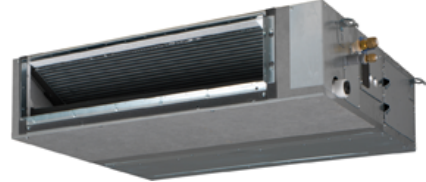

FXDQ-A



FXNQ-A, FXDQ-A: specific settings

13/ 23	5	External static pressure	01	Default: Standard (10 Pa)
			02	High static pressure setting (30 Pa)
			03	Medium static pressure
			04	Medium static pressure

FXSQ-A, FXMQ-P/M, FXTQ-A: specific settings

				FXSQ-A	FXMQ-M	FXMQ-P	FXTQ-A	Comment
13/ 23	6	External static pressure (Pa)	01	30	Std ESP	30	Tbc	ESP value based on nominal airflow rate = Hhspeed Possible available settings depend on outdoor unit size (see corresponding IM)
			02	-	High ESP	50	Tbc	
			03	30		60	Tbc	
			04	40		70	Tbc	
			05	50		80	Tbc	
			06	60		90	Tbc	
			07	70		100	Tbc	
			08	80		110	Tbc	
			09	90		120	Tbc	
			10	100		130	Tbc	
			11	110		140	Tbc	
			12	120		150	Tbc	
			13	130		160	Tbc	
			14	140		180	Tbc	
			15	150		200	Tbc	
11/ 21	7	Auto-adjustment of ESP	01	Deactivated, manual through 13/23-6			/	Only applicable for FXSQ and FXMQ
			02	Auto-adjustment				
			03	Start auto-adjustment				

12. Factory settings

12.1. How to perform factory reset of settings through remote

Only for BRC2/3E52, BRC1E51/52

1. Power off unit and wait for display to go blank
2. Push 3 buttons simultaneously and power on unit while holding 3 buttons until initialisation starts again



Reset of:

- timer
- clock
- language
- settings 1b, 1c, 1e
- configuration settings in user menu

<https://daikin-p.ru>

12.2. Field settings as per type indoor unit

Field set	Code	FXKQ-M	FXFQ-P	FXCQ-A	FXSQ-P	FXDQ-M	FXUQ-A	FXFQ-A	FXMQ-P	FXHQ-A	FXDQ-A	FXZQ-A	FXAQ-P/A	FXLQ	FXNQ	VKM	Biddle	FXSQ-A	FXTQ-A		
20	Indoor	BRC...																			
	0	01	01	01	01	02	01	01	01	01	01	01	01	01	01	01	01	tbc	tbc	tbc	
	1	na	01	01	na	na	01	01	na	01	04	01	01	na	na	03	01	tbc	tbc	tbc	
	2	02	02	02	02	02	02	02	02	02	01	02	03	02	03	na	03	tbc	tbc	tbc	
	3	03	02	01	02	02	01	01	01	01	01	01	01	01	02	02	02	tbc	tbc	tbc	
	4											spare									
	5	na	02	01	02	01	01	01	01	02	01	01	01	02	02	na	01	tbc	tbc	tbc	
	6	na	02	01	02	01	01	01	01	02	01	01	01	02	02	na	01	tbc	tbc	tbc	
	7	na	na	01	na	na	01	01	01	na	na	01	01	na	na	na	na	tbc	tbc	tbc	
8	na	02	01	na	na	01	01	01	na	02	01	02	na	na	na	na	tbc	tbc	tbc		
9											spare										
21	0																				
	1																				
	2																				
	3	na	01	01	na	na	01	01	na	01	01	01	na	na	na	na	na	tbc	tbc	tbc	
	4																				
	5																				
	6	na	na	03	na	na	03	03	na	na	04	03	na	na	na	na	na	tbc	tbc	tbc	
	7	na	na	na	02	na	na	na	01	01	na	na	na	na	na	na	na	tbc	tbc	tbc	
	8	na	na	03	na	na	03	03	01	na	na	01	03	na	na	na	na	tbc	tbc	tbc	
9	na	na	03	na	na	03	03	03	na	03	03	03	na	na	na	na	tbc	tbc	tbc		
22	0	02	01	01	01	02	01	01	01	01	01	01	01	01	01	01	Biddle	FXSQ-A	FXTQ-A		
	1	02	01	01	01	01	01	01	02	01	01	01	01	01	01	01	01	tbc	tbc		
	2	02	02	01	02	01	01	01	02	02	02	01	02	02	02	01	01	tbc	tbc		
	3	01	01	03	01	01	01	01	02	01	01	01	01	01	02	na	01	tbc	tbc		
	4	01	03	01	02	03	03	02	03	03	01	01	01	01	03	01	01	tbc	tbc		
	5	02	02	02	02	02	02	02	02	02	02	02	02	02	02	02	02	tbc	tbc		
	6	na	02	02	01	02	02	02	02	02	02	02	02	na	na	na	tbc	tbc			
	7	na	01	01	01	01	01	01	01	01	01	01	01	na	na	na	01	tbc	tbc		
	8	na	01	01	01	01	01	01	01	01	01	01	01	na	na	na	01	tbc	tbc		
9	01	01	01	01	01	01	01	01	01	01	01	01	01	01	01	01	tbc	tbc			
23	0	na	01	01	01	na	01	01	01	01	01	01	01	na	na	VKM	Biddle	FXSQ-A	FXTQ-A		
	1	na	01	na	na	na	01	01	na	na	na	01	01	na	na	na	na	tbc	tbc		
	2	na	na	01	na	na	03	01	na	na	na	01	na	na	na	na	na	tbc	tbc		
	3	01	na	na	na	na	na	na	na	na	na	01	01	na	na	na	na	tbc	tbc		
	4	02	01	01	na	na	03	03	03	03	02	01	02	na	na	na	na	tbc	tbc		
	5	na	01	01	01	na	01	01	01	01	01	01	01	na	na	na	na	tbc	tbc		
	6	na	na	na	15	na	na	na	02	na	na	na	na	na	na	na	na	tbc	tbc		
	7	na	01	01	na	na	01	01	na	01	01	01	01	na	na	na	na	tbc	tbc		
	8	na	na	na	na	na	na	na	na	na	na	na	na	na	na	01	02	tbc	tbc		
9	na	01	01	01	09	01	01	01	01	01	01	01	na	na	na	01	tbc	tbc			

	FXKQ-M	FXFQ-P	FXCQ-A	FXSQ-P	FXDQ-M	FXUQ-A	FXFQ-A	FXMQ-P	FXHQ-A	FXDQ-A	FXZQ-A	FXAQ-P/A	FXLQ	FXNQ	VKM	Biddle	FXSQ-A	FXTQ-A	
24	spare																		
0	na	01	01	01	na	01	01	02	01	01	01	na	na	na	13	na	tbc	tbc	
1	na	01	na	na	na	na	02	na	02	na	na	na	na	na	na	na	tbc	tbc	
2	na	01	na	na	na	na	01	na	01	na	na	na	na	na	01	na	tbc	tbc	
3	na	01	na	na	na	na	01	na	01	na	na	na	na	na	09	na	tbc	tbc	
4	na	01	na	na	na	na	01	na	01	na	na	na	na	na	na	na	tbc	tbc	
5	na	01	na	na	na	na	01	na	01	na	na	na	na	na	05	na	tbc	tbc	
6	na	na	na	na	na	na	na	na	na	na	na	na	na	na	01	01	tbc	tbc	
7	01	01	01	01	01	01	01	01	01	01	01	01	02	01	01	01	tbc	tbc	
8	na	02	na	na	na	na	02	na	02	na	na	na	na	na	na	na	tbc	tbc	
9	na	01	na	na	na	na	01	na	01	na	na	na	na	na	na	04	tbc	tbc	
25	spare																		
0	na	02	02	02	na	02	02	01	02	02	02	FXAQ-P/A	FXLQ	FXNQ	VKM	Biddle	FXSQ-A	FXTQ-A	
1	01	01	01	01	01	01	01	02	01	01	01	na	na	02	na	na	tbc	tbc	
2	na	01	01	na	na	01	01	na	01	01	01	01	na	na	na	na	tbc	tbc	
3	01	01	01	01	01	01	01	01	01	01	01	01	01	01	02	01	tbc	tbc	
4	na	01	01	01	na	01	01	01	01	01	01	01	na	na	na	na	tbc	tbc	
5	01	01	01	01	01	01	01	01	01	01	01	01	01	01	01	01	tbc	tbc	
6	01	01	01	01	01	01	01	01	01	01	01	01	01	01	01	01	tbc	tbc	
7	spare																		
8	spare																		
9	01	01	01	na	01	na	01	01	01	01	01	01	01	01	01	01	tbc	tbc	